

TECHNICAL FILE

PRODUCT RANGE: KING

CODE: KING-GB60PC-00

DESCRIPTION: GRAB BAR 60 CM/24IN POWDER COATED STEEL WHITE

PRODUCT FEATURES:

The products of the KING Grab Bar line allow to increase independence while taking a shower or while standing up and sitting down on the toilet bowl or in the bathtub. They work as a robust and safe handle, on which the user can hold on in order to relieve part of the body weight from the legs, reducing muscle fatigue due to standing position as well as slip and injuries risks. It can be installed in different places in the bathroom, depending on the user requirements.

MECHANICAL PERFORMANCE:

Max user weight 150 kg; 330 lb

CERTIFICATIONS:

N/A

APPLICABLE NORMS:

EN ISO 14001:2015; EN ISO 10993-5:2009; EN ISO 10993-10:2013

MAINTENANCE:

Periodically check that fixing fittings conform to initial mounting. Clean with water and non-aggressive detergent. Do not use abrasive or corrosive products.

PRODUCT PACKAGING:

Box dimensions: 697x93x88 mm.
Gross Weight: N/A kg.
Net Weight: N/A kg.

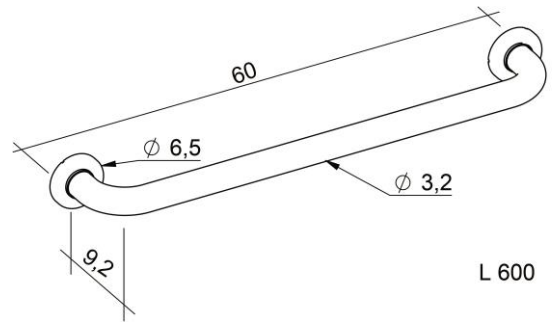

L 600

PACKAGING COMPONENTS	Q.TY	CODE
Retail Box	1	RI-BOX-24-B
Shipping Carton	1/10	SC-KING60M-00
User Manual	1	UM-KINGGB0M-00
Single Box Label	1	BL-BKINGGB60PC-00
Shipping Carton Label	1/10	SL-BKINGGB60PC-00

PRODUCT COMPONENTS	Q.TY	MATERIAL	REF.
Tube 60 cm Steel	1	Stainless Steel	3
Flange	2	PA	2
Screw Cover	2	Stainless Steel	4
Screws	2	Steel	5

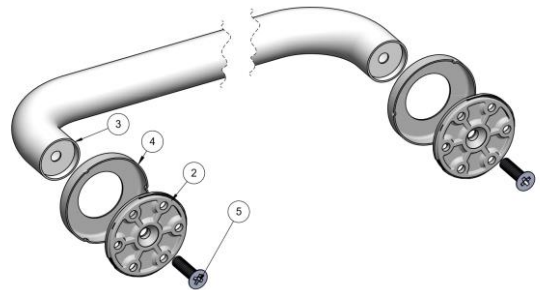

The above data cannot be binding. LM Global Design Ltd. reserves itself the right to make technical or aesthetic modifications without notice at any time.