

TECHNICAL FILE

PRODUCT RANGE: KING

CODE: KING-15-00

DESCRIPTION: RTS 15 CM/6" KING

PRODUCT FEATURES:

The KING Raised Toilet Seat line is designed for those who have difficulties in sitting or standing up when using the toilet: the elderly, post-operative patients and for wheelchair users to facilitate transfer. The ergonomically designed surface area of the seat reduces pressure offering increased user comfort. The slight downward incline of the seat promotes correct posturing and reduces flexing of the hip and knee joints. The contoured seat incorporates both rear and frontal openings allowing greater access for personal hygiene. Suitable for the majority of toilet bowls. The seat is made of polypropylene offering durability, strength and warmth. The finished surface is easy to clean and resists stains and smells.

MECHANICAL PERFORMANCE:

Max user weight 250 kg; 550 lb.

CERTIFICATIONS:

CE Declaration of conformity of the European Directive for Medical Device 93/42 EEC.

APPLICABLE NORMS:

UNI EN 12182; UNI CEI EN ISO 14971; UNI EN 1041.

MAINTENANCE:

Periodically check that fixing fittings conform to initial mounting.
Clean with water and non-aggressive detergent.
Do not use abrasive or corrosive products.

PRODUCT PACKAGING:

Box dimensions: 369X164X410 mm.
Gross Weight: 1.46 kg.
Net Weight: 1.175 kg.



H = 15 cm

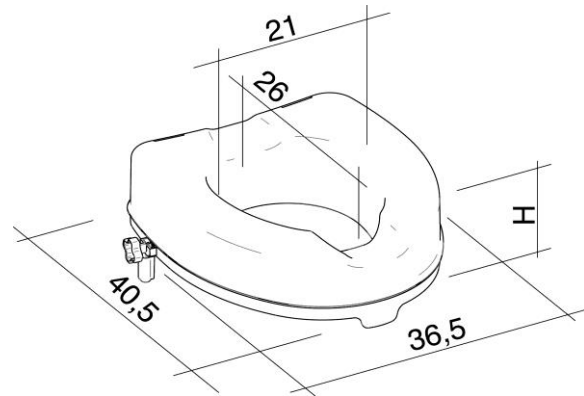

PACKAGING COMPONENTS	Q.TY	CODE
Box	1	FB-KING15L-00
RTS Poly Bag	1	PB2-01
Locking System Kit Poly Bag	1	PB1-01
User Manual	1	UM-KINGR0-00
Box Label	1	BL-BKING15-00

PRODUCT COMPONENTS	Q.TY	MATERIAL	REF.
Raised Toilet	1	Polypropylene 30% CC	1
Caps	2	Polypropylene 30% CC	2
Locking System Kit	1	PA6; TPR	3/4

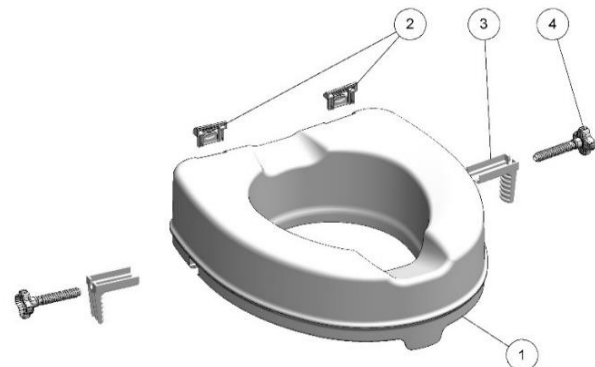

Ref. Technical File KING-15-00 Rev 03 as of 03 2021

The above data cannot be binding. LM Global Design Ltd. reserves itself the right to make technical or aesthetic modifications without notice at any time.